

# FAGERHULT

SE - 566 80 Habo

## Nove

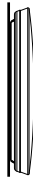
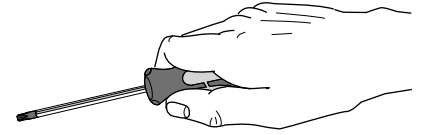

IP40  
 Ø 360  
 Ø 420  
 Ø 520



IP41 Ø 360  
 IP41 Ø 420  
 IP41 Ø 520

With Decor edging



IP44 Ø 360  
 IP44 Ø 420  
 IP44 Ø 520

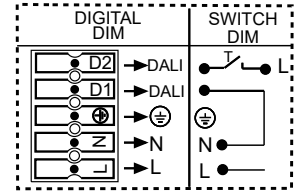
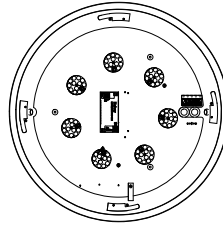

Decor edging  
 Dekorkant

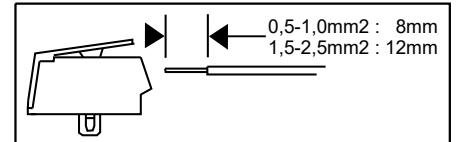
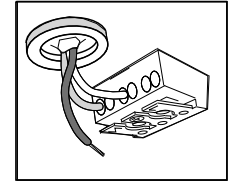
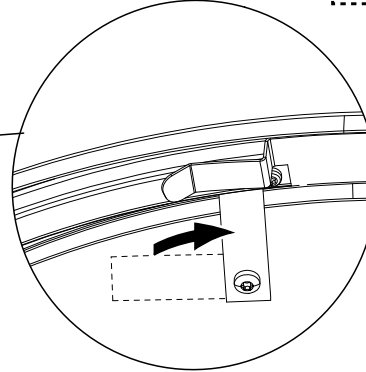
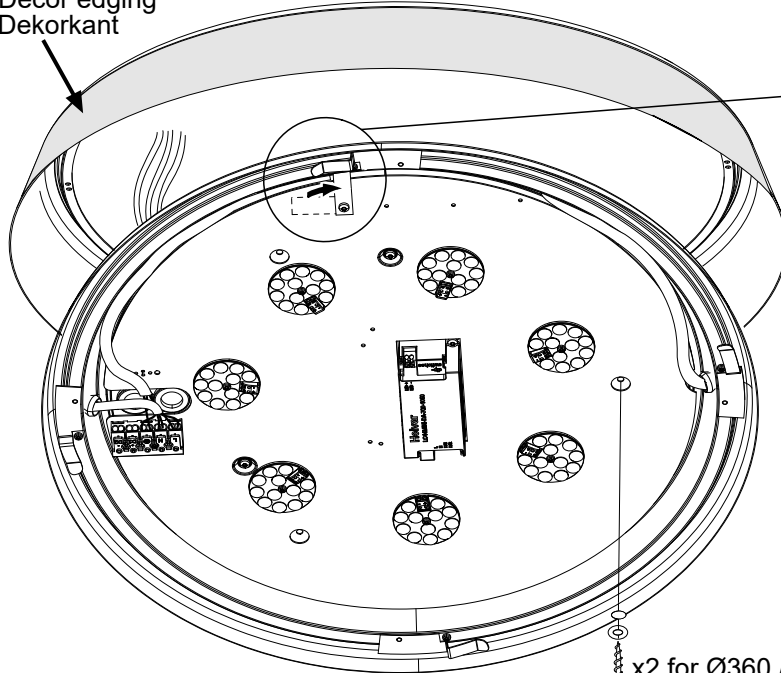

x2 for Ø360 / Ø420  
 x3 for Ø520

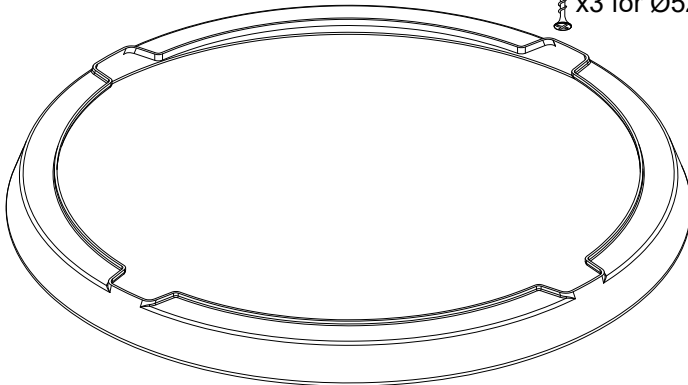

- (GB)** The luminaire must be connected to earth. ⊕
- (S)** Armaturen måste anslutas till skyddsjord. ⊕

- (S)** Förlägg ej ledningar mot ledmodulerna.
- (GB)** Don't place the wiring against ledmodules.

- (S)** För att uppnå IP41 måste armaturen monteras på ett tätt tak, där taket måste sträcka sig minst 10mm utanför armaturens ytterdiameter.

- (GB)** To achieve IP41 the luminaire must be mounted on a water tight ceiling, which reach minimum 10 mm outside the luminaire outerdiameter.

10mm

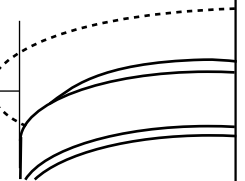

When mounting decor ring on wall

x4 Remove and fasten from outside

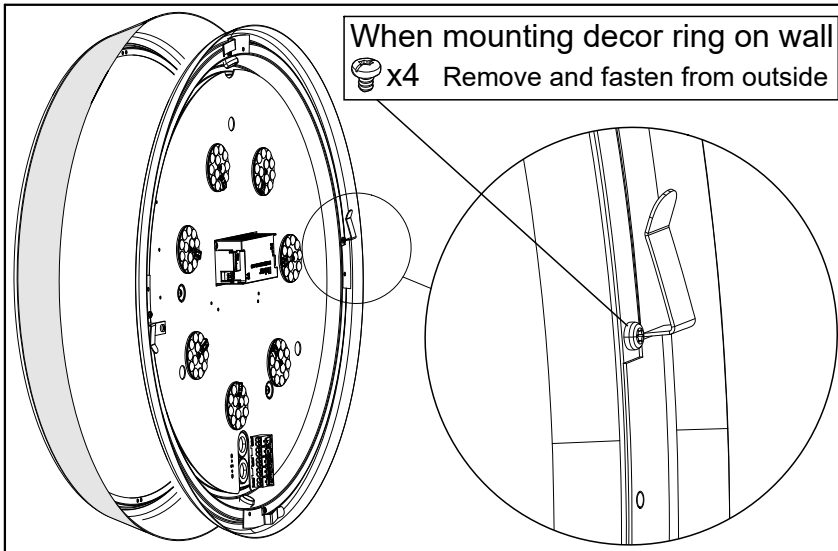

- |  |   |
|--|---|
|  | } <b>(S)</b> Grundläggande isolering mellan nät och styr ledning. |
|  |   |
|  | } <b>(GB)</b> Basic insulation between mains and control wiring.  |
|  |   |
|  |   |

Manufactured by Fagerhult  
 For UK market importer Fagerhult UK  
 33-34 Dolben Street, London, SE1 0UQ

- (S)** Ljuskälla och drivdon ska enbart bytas ut av tillverkaren eller dess utsedda person.

- (GB)** The light source and control gear shall only be replaced by the manufacturer or its designated person.

- (S)** Det är lämpligt att denna information överlämnas till användaren av anläggningen.

- (GB)** It is appropriate that this information is passed on to the users of the installation.

- (D)** Diese Informationen sind für den Benutzer der Anlage vorgesehen.

- (SF)** Nämä ohjeet tulee säilyttää ja luovuttaa kiinteistön käyttäjälle.

# FAGERHULT

SE - 566 80 Habo

## Nove Detect DALI

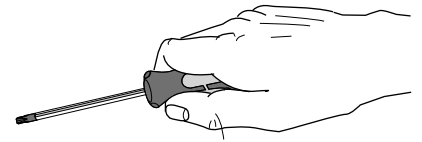

IP40  
 Ø 360  
 Ø 420  
 Ø 520

IP41 Ø 360  
 IP41 Ø 420  
 IP41 Ø 520

With Decor edging  
 IP44 Ø 360  
 IP44 Ø 420  
 IP44 Ø 520

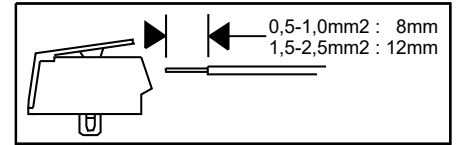

(S) För att uppnå IP41 måste armaturen monteras på ett tätt tak, där taket måste sträcka sig minst 10mm utanför armaturens ytterdiameter.

(GB) To achieve IP41 the luminaire must be mounted on a water tight ceiling, which reach minimum 10 mm outside the luminaire outer diameter.

10mm

Manufactured by Fagerhult  
 For UK market importer Fagerhult UK  
 33-34 Dolben Street, London, SE1 0UQ

(GB) The luminaire must be connected to earth. (⊕)

(S) Armaturen måste anslutas till skyddsjord. (⊕)

(S) Förlägg ej ledningar mot ledmodulerna.

(GB) Don't place the wiring against ledmodules.

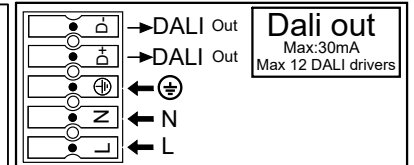
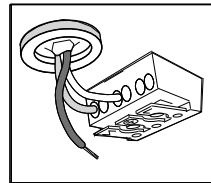

x2 for Ø360 / Ø420  
 x3 for Ø520

### e-Sense Detect DALI

Operating frequency bands and output power (EIRP):  
 Frequency band: 5.8 GHz +/- 75 MHz (HF)  
 Output power (<0.2mW (HF) within our operating band)

Härmed försäkrar Fagerhult att dessa typer av radioutrustningar 57100R3, 57102R3, 57104R3.

överensstämmer med direktiv 2014/53/EU.

Hereby, Fagerhult declares that this radio equipment types

57100R3, 57102R3, 57104R3.

are in compliance with Directive 2014/53/EU and UK SI 2017 No. 1206.

Den fullständiga texten till EU-försäkran om överensstämmelse

finns på följande webbadress: [www.fagerhult.com/declaration-of-conformity](http://www.fagerhult.com/declaration-of-conformity)

The full text of the EU declaration of conformity is available

at the following internet address: [www.fagerhult.com/declaration-of-conformity](http://www.fagerhult.com/declaration-of-conformity)

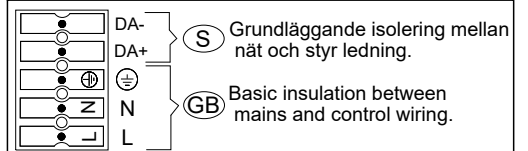

(S) Ljuskälla och drivdon ska enbart bytas ut av tillverkaren eller dess utsedd person.

(GB) The light source and control gear shall only be replaced by the manufacturer or its designated person.

(S) Det är lämpligt att denna information överlämnas till användaren av anläggningen.

(GB) It is appropriate that this information is passed on to the users of the installation.

(D) Diese Informationen sind für den Benutzer der Anlage vorgesehen.

(SF) Nämä ohjeet tulee säilyttää ja luovuttaa kiinteistön käyttäjälle.

Decor edging  
 Dekorkant

When mounting decor ring on wall

x4 Remove and fasten from outside

# FAGERHULT

SE - 566 80 Habo

## Nove E-sense flex

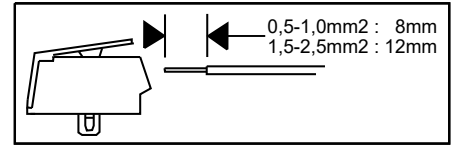
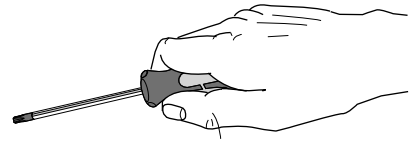

IP40  
Ø 360  
Ø 420  
Ø 520



With Decor edging



IP41 Ø 360  
IP41 Ø 420  
IP41 Ø 520

IP44 Ø 360  
IP44 Ø 420  
IP44 Ø 520

Decor edging  
Dekorkant

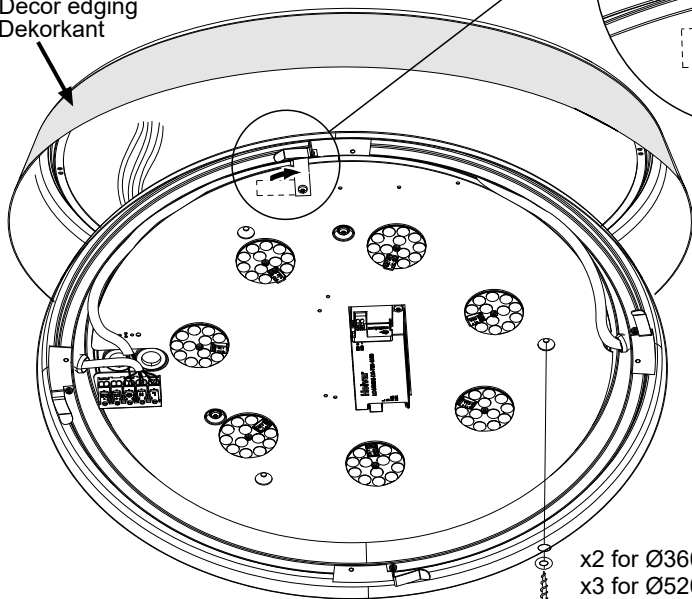

x2 for Ø360 / Ø420  
x3 for Ø520

**S** För att uppnå IP41 måste armaturen monteras på ett tätt tak, där taket måste sträcka sig minst 10mm utanför armaturens ytterdiameter.

**GB** To achieve IP41 the luminaire must be mounted on a water tight ceiling, which reach minimum 10 mm outside the luminaire outerdiameter.

10mm

Manufactured by Fagerhult  
For UK market importer Fagerhult UK  
33-34 Dolben Street, London, SE1 0UQ

**GB** The luminaire must be connected to earth. ⊕

**S** Armaturen måste anslutas till skyddsjord. ⊕

**S** Förlägg ej ledningar mot ledmodulerna.

**GB** Don't place the wiring against ledmodules.

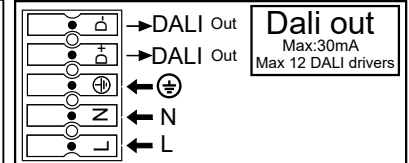
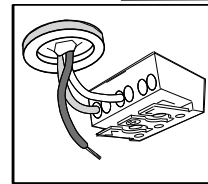

### e-Sense Flex, Hytronik KoolMesh firmwire

Operating frequency bands and output power (EIRP):

Frequency band: 5.8 GHz +/- 75 MHz (HF)

Output power (<0.2mW (HF) within our operating band)

Operating frequency bands and output power (EIRP):

Frequency band: 2.4 GHz

Output power (4dBm max within our operating band)

Härmed försäkrar Fagerhult att dessa typer av radioutrustningar 57100R4, 57102R4, 57104R4.

överensstämmer med direktiv 2014/53/EU.

Hereby, Fagerhult declares that this radio equipment types

57100R4, 57102R4, 57104R4.

are in compliance with Directive 2014/53/EU and UK SI 2017 No. 1206.

Den fullständiga texten till EU-försäkran om överensstämmelse

finns på följande webbadress: [www.fagerhult.com/declaration-of-conformity](http://www.fagerhult.com/declaration-of-conformity)

The full text of the EU declaration of conformity is available

at the following internet address: [www.fagerhult.com/declaration-of-conformity](http://www.fagerhult.com/declaration-of-conformity)

When mounting decor ring on wall

⚙️ x4 Remove and fasten from outside

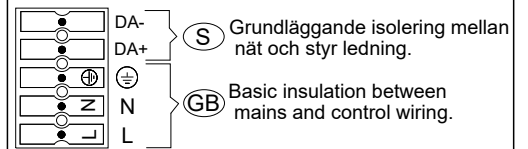

**S** Ljuskälla och drivdon ska enbart bytas ut av tillverkaren eller dess utsedd person.

**GB** The light source and control gear shall only be replaced by the manufacturer or its designated person.

**S** Det är lämpligt att denna information överlämnas till användaren av anläggningen.

**GB** It is appropriate that this information is passed on to the users of the installation.

**D** Diese informationen sind für den Benutzer der Anlage vorgesehen.

**SF** Näämä ohjeet tulee säilyttää ja luovuttaa kiinteistön käyttäjälle.